



40W



3200LM



IP68



**MULTI-VOLT
9-32V**



EMC CISPR 25 – Class 4



LED-flood

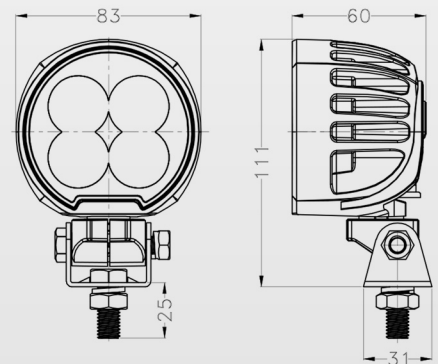
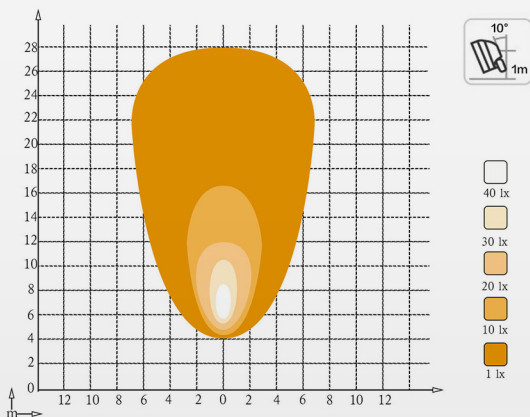

Model: VX40

SPECIFICATIONS:

Power	40W
Voltage range	9-32V
Luminous flux	3200LM
Light type	4pcs OSRAM 10W
Waterproof rate	IP68
Material	PC lens
Operating temperature	-45°C-+85°C
Beam	flood and spot beam optional
Material of housing	aluminum alloy
EMC CISPR 25 – Class 4	



Deutsch connector 2-pin Optional